



COCHIN STEEL LLC

Manufacturing Excellence **redefined!**



Contents

Introduction	03
Quality & Safety Policy	04
License & Certificates.....	05
Our Range of Products	06
Fuel Storage Tanks Solutions.....	07
Stainless Steel Storage Tanks	08
Oil Field Equipments.....	09
Bulk Water Storage Tanks	10
Tanker & Trailers	11
General Steel Fabrication Works	12
Silos (Gravity & Pressurized)	13
Pipeline & Fittings.....	14
Fuel Management Solutions & related Accessories	15
Containerized Solution For Fuels	18
Engineering & Design Services.....	19



Introduction



Cochin Steel LLC. is one of the leading design & fabrication company engaged in the manufacturing and installation of storage tanks for Diesel, Petrol, Water and Chemical tanks. We also undertake customized fabrication services like Oxy Fuel Cutting, Plate Rolling, Dished Ends Manufacturing, MIG Welding, Arc Welding, Machine Shop Works etc. Our specialized water storage tanks made of ZINCALUME and GLS are the industry leading solutions for water storage for fire water as well as irrigation water requirements. Based in UAE, Cochin Steel is a market leader and pioneer in this industry and have been serving our esteemed clients with top-of-the-line products and services since 2006.

We have state-of-the-art manufacturing infrastructure that is well equipped with latest machinery and tools that allow us to meet the exact demands of the clients in an effective manner. Moreover, the in-depth knowledge of our workforce helps us to cater to industrial fabrication services as per the exact requirements of our clients. This is the reason why our storage tanks for diesel and other fuels are the best in the market.

“ *Our strong business ethics, transparent fair dealings, and client centric approach has helped us to attain maximum client satisfaction.* ”



Our strong business ethics, transparent fair dealings and client centric approach has helped us to attain maximum client satisfaction. Owing to durable finish standards and abrasion resistant finish and quality of basic materials, our tanks find wide applications in varied industrial sectors. Featuring precision fabricated bodies, the tanks are designed for durable and reliable performance and require minimum maintenance. The Tanks are also available in different specifications. We also specialize in dished ends from 1m to 3.4m diameter. With more than 200,000++ tank installations in the UAE and the MENA region, we can safely say that we are one of the best companies for all your fabrication requirements.



Quality Policy

Cochin Steel LLC is involved in manufacturing of steel storage tanks, road tankers, trailers, steel fabrication and their associated business administration and has a vision to be synonymous with professionalism and innovation together with faultless and safe project delivery in every operational area.

A key way to achieve this is by operating a Quality Management System (QMS) in accordance with the requirements of ISO 9001:2015.

Top management is committed to:

- Satisfying applicable requirements by ensuring that customer and applicable statutory and regulatory requirements are determined, understood and consistently met.
- Continual improvement of the QMS by ensuring the risks and opportunities that can affect conformity of products and services and the ability to enhance customer satisfaction are determined and addressed and the focus on enhancing customer satisfaction is maintained.

Top management shall:

- Take accountability for the effectiveness of the QMS.
- Ensure the quality policy and quality objectives are established for the QMS and are compatible with the context and strategic direction of the Company. Quality objectives have been set and are maintained as part of the QMS internal auditing, monitoring and management review processes, in order to enhance customer satisfaction.
- Promote the use of a process approach and risk-based thinking.
- Ensure that the resources needed for the QMS are available; including training, support and encouragement.
- Communicate the importance of effective quality management and of conforming to the QMS requirements.
- Ensuring that the QMS achieves its intended results.
- Engage, direct and support persons to contribute to the effectiveness of the QMS.
- Promote improvement.
- Support other relevant management roles to demonstrate their leadership as it applies to their areas of responsibility.
- Establish partnerships with suppliers and interested parties to provide an improved service.

This policy will be communicated to all employees and organizations working for or on our behalf. Employees and other organizations are expected to co-operate and assist in the implementation of this policy, whilst ensuring that their own work, so far as is reasonably practicable, is carried out without risk to themselves, others, or the environment.

This policy will be reviewed annually by top management and where deemed necessary will be amended and re-issued. Previous versions of this policy are archived.

This policy is available to relevant interested parties, upon reasonable request.

Managing Director

Date: 01/05/2017

Issue No.: 01

Ref No: QMS/CS/QP/02

	HSE POLICY	CS-IMS-P-02
		Rev 00

Cochin Steel LLC is engaged in a business of Storage Tanks Products, Oilfield Products and Transportation Products. We shall remain committed to protection of the Health and Safety of our staff, employees, visitors, subcontractors and the community at large and protect the physical environment in which the company activities are carried out.

The Management and Staff of Cochin Steel LLC are committed to:

- Ensuring the safety and welfare of our staff and the protection of our assets.
- Shall be determined to fulfill our commitments and services that meet the needs and expectations of our customers.
- Ensuring the prevention of any impact on the environment resulting from our actions.
- Complying with all relevant Health & Safety, Environmental legal laws and other regulatory requirements.
- To identify the hazards (the potential for harm) assess the risks (the likelihood of that harm being realized) and manage those risks.
- To maintain work equipment in a safe state and provide both safe systems of work and a safe working environment for employees and all who work on our behalf.
- Periodically review the suitability, adequacy and effectiveness of the HSE management system.
- Strive to prevent any incidents, occupational illness or exposures which could cause harm to people and damage to properties and assets and the environment and maintain Emergency Plans to reduce risks and adverse effects.
- Make every effort to protect the environment and prevent pollution, to minimize consumption of materials, to promote reuse and recycling of wastes and adopt best practice on waste management.
- Strive to achieve continual improvement through implementation and review of the HSE management system and related performance.
- To prevent accidents and cases of work-related ill-health.
- Policy will be reviewed periodically and will be available for employee and public.

These commitments will be achieved by:

- Establishing and maintaining a documented Health, Safety and Environmental Management System (HSEMS).
- Ensuring procedures, program and guidelines are in place to support the HSEMS.
- Providing the necessary HSE resources for the implementation of the Management System
- Communicating the Company's HSE policy and Objectives to relevant interested parties including its employees, stake holder, clients and customers.
- Setting, monitoring and reviewing HSE targets and objectives.
- Complying with HSE Policy.

MD

Date: 10-05-2021



License & Certificates

GOVERNMENT OF SHARJAH
Economic Development Department

حكومة الشارقة
المركز التنموي الاقتصادي

رخصة صناعية
Industrial License

دليل المشاركة الصناعية
Sharjah Industrial Guide

تفاصيل الرخصة License Details

رقم الرخصة License No.	542776	رقم التسجيل Registration No.	57499
تاريخ الإصدار Issue Date	2006/05/01	تاريخ الانتهاء Expiry Date	2024/04/30
الاسم التجاري Trade Name	COCHIN STEEL LLC	الشكل القانوني Legal status	Limited Liability Company

أطراف الرخصة License Members

رقم المستثمر Investor No.	اسم المستثمر Investor Name	الجنسية Nationality	رقم الهوية / الجواز ID/Passport No.	الصفة Type	الحصص Shares
62688	فيود جوسي ألبينجكال يوسف جوسي	الهند	784197224975900	شريك	%95
4872525	بيلي سبسي أراكيل	الهند	784198015321478	شريك	%5

العنوان
صناعة الآلات المعدنية للمباني نشاط 24 ساعة
الشارقة-المنطقة الصناعية/الشارقة- خلف شارع رقم 1-مسكنة أرض مسورة ملك حين خبيس بوطوط

ملاحظات Notes
- يرجى ته بريونة النشاط 24 ساعة بخرج شركة / شركة، ودخل المخر / المخر

تاريخ الصادرة Issue Date	2023/07/11
رقم الترخيص License No.	39795

* This document is official. It doesn't need to be stamped or signed.
To view license details please visit SEDD web site: www.sedd.ae
It is prohibited to distribute advertisements in public places and residential areas.
A permit is required when conducting any promotion.

مجلس غرفة التجارة والصناعة
Sharjah Chamber of Commerce & Industry

شهادة التسجيل السنوية
Membership Registration Certificate For Year

[2023]

الهيئة العامة للتجارة والصناعة
Sharjah Chamber of Commerce and Industry according to the Decree No. 99 / 2018

رقم الترخيص License No.	542776
رقم التسجيل التجاري Commercial Registration No.	57499
القطر Category	الصناعة
جنسية الشركاء Partners Nationality	الهند

رقم العضوية Membership Number	073917
الجنسية Nationality	الهند
نوع الشكل القانوني Legal Form	شركة ذات مسؤولية محدودة
العنوان Address	شارقة-المنطقة الصناعية/الشارقة- خلف شارع رقم 1-مسكنة أرض مسورة ملك حين خبيس بوطوط
النوع Activity	صناعة الآلات المعدنية للمباني - نشاط 24 ساعة Building Metal Products Manufacturing - 24 Working Hours
رمز الشركة Remarks	

SHARJAH ALSAMA INDUSTRIAL ZONE ST

تاريخ الصادرة Issue Date

16/09/2023

M 241519

Certificate

SWISS CERT Pvt. Ltd. hereby certify that the Quality Management System of

COCHIN STEEL LLC
SAJJA INDUSTRIAL AREA, SHARJAH - 664 49, UAE

has been assessed and found to be in accordance with the requirements of

Quality Management System ISO 9001:2015

and scope of activities are detailed below as per IAF/NACE Code: 17:25.2

**MANUFACTURING, INSTALLATION AND COMMISSIONING OF STEEL TANKS,
SILOS AND TURNKEY LIQUID HANDLING SYSTEM**

This Certificate is valid for a period of Three years from: 26.08.2021 until: 25.08.2024
And remains valid Subject to satisfactory completion of surveillance audits

Certificate Number: 211329
Rev. No: 00

SWISS CERT PVT. LTD.
CH-80007 Fribourg, Switzerland
This certificate is the property of SWISS CERT PRIVATE LIMITED and shall be returned upon request.
All referenced parties are advised to verify the validity of the certificate from SWISSCERT ([info@swisscert.ch](http://info.swisscert.ch))

**IN-COUNTRY VALUE
CERTIFICATE**

Certificate ID: 127137
Issue Date: 06.09.2023
Valid Until: 09.09.2024

COCHIN STEEL LLC

34.62%

Company General Information
License No.: 542776
Company Type: SME in UAE
Financial Year End Date: 31.12.2022
Company based in: Within UAE
Company Business: GOOD MANUFACTURER

For Cases of Re-Certification
Re-Certification (*) No:

Reason for this Re-Certification

Signed By
On behalf of Supplier

Name:
Vinoch Jose Elinjikkal

Designation:
Managing Director

Verified as per ICV Agreed Upon Procedures (AUP)
On behalf of Certification Body

Name:
Jaffer A. Rupawala

Designation:
Partner

Company:
Mazars Chartered Accountants - LLC

Certificate Issued Based on ICV Version: 3.0



Our Products Range



Storage
Tanks



Oil Field
Products



Bulk Water
Storage Tanks



Road Tankers/
Trailers



Fabrication
Support



Customized
Steel Fabrication



Silos and Associated
Accessories



Pipeline
Work



Fuel Management
Solutions

Whether it's tanks, tankers, silos, or any fuel management solutions; we at Cochin Steel have got you covered with our wide range of customized products.

We are available during our business hours on +971 6 5310520 or get connected to us by simply emailing us at sales@cochinsteeluae.com





Capacity: 500L - 150,000L
 Material: ASTM A36/ S275JR/ 516
 Grade 70/ 516 Grade 60
 Orientation: Horizontal/ Vertical
 Shape: Cylindrical/ Vertical/ Containerized/ Cube

Manufacturing in compliance with industry leading standards



Catalogue





Capacity range: 1000L-150,000L

Grade: ASTM A36/ S275JR/ Grade 50/ Grade 70/ SS304/ SS316L

Cladding: Rockwool/ GRP/ FRP

Agitator and Control Panel: As per application



Oil Field Equipments



Air Receiver Tank



Skid Mounted Recirculation Storage tank



500 Bbl Skid Mounted Recirculation tanks



MBBR Tanks



SKID Frames



Bitumen Storage Tank



500 BBL Skid Mounted Storage Tanks

Mud Recirculation Tanks

Frac Tankers

Air Receiver Tanks

Skid Mounted Tank Packages

Metering Skids



Bulk Water Storage Tanks



Steel Bolted Panel Tanks



Steel Bolted Panel Tanks

Construction: Bolted type/ Welded Type

Capacity: 100m³- 5000m³

Material: Alu-Zinc AZ150/ GI Z250/ GLS

Warranty: Industry leading 10 years Limited warranty



Tankers / Trailers



Grease Trap Tanker



Fuel Bowser



Water Tanker



Diesel Tanker



Sewage Tanker



Bitumen Tanker



Water Tanker



Fuel Tanker

Grease Trap Tankers with full accessories.

JET A1 Bowsers

Diesel/ Petrol Bowsers

Sweet Water Tankers

Vacuum Tankers (Open/ Closed end type)

Bitumen Tankers

Salt Water Tankers

Diesel tanker with dispensers





General Steel Fabrication Works



Cable Reel Frame



Heavy Duty Industrial Cabinets



Transformer Cage



Hose/ Cable Reels

Flue Stacks

Work Benches

Containerized solutions

Chimneys

Skid frames

Loading Ramps

Offshore cargo basket DNV 2.7-1

Silos (Gravity & Pressurized)



Cement Silo



Cement Silo



Pressurized Silo

Capacity: 50 Tons to 500 Tons

Material: ASTM A36/ S275JR/ 516 Grade 70/ 516 Grade 60/ SS304/ SS316L

Construction: Welded/ Bolted

Shape: Cylindrical with flat/conical bottom

Accessories: As per client requirements



Pipeline & Fittings



Capacity: 1/2" - 18"

Material: MS/ SS/ UPP / HDPE

Brands:





Fuel Station/Depot Design, Engineer and Build Solutions



Fuel Depot Station at Dubai Parks



Fuel Station ADNOC Labour Camp Habshan



Al Rawabi Bio Gas Plant Al Khawaneej, Dubai UAE



Fuel Farm, Marmum Dairy Farm Al Ain, UAE



Turnkey fuel station design, engineering and build solution.
Working with industry leading brands like



Completed several prestigious projects for



AMC/ Long term service contracts available



Tank Accessories



FUEL SYSTEMS



Our ASTs and USTs can be equipped with European or American approved instrumentations to protect your Tanks from leak, spillage or fire hazards, We can provide different applications based on your requirement and budget.

Fuel Systems can work in harmony with Generator's base tanks or day tanks. We offer spotted leak detection both for pipe works and Tanks bund walls.



ZONE VARIETIES

We supply and install steel tanks and accessories in different zones and applications, with access to reputable brands and experienced personnel we can ensure that your investment is safe in different safety zones.

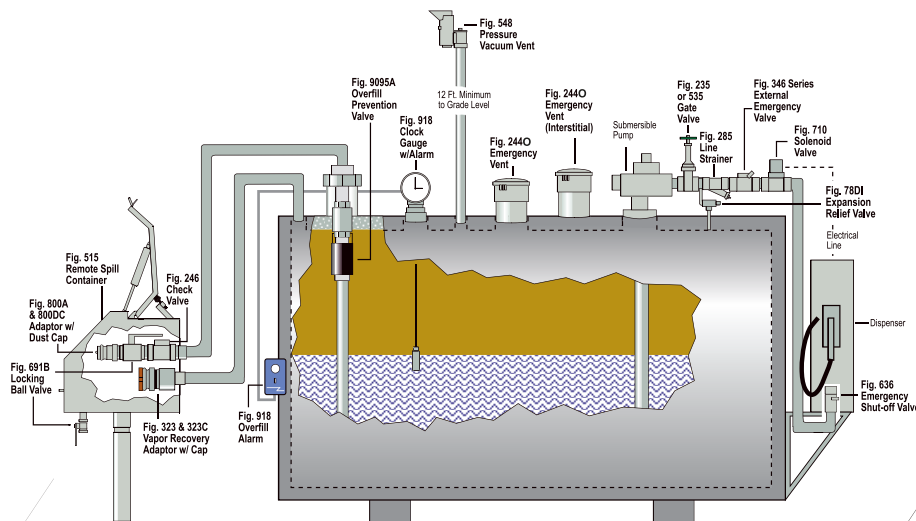

PRESSURE/ VACUUM VENTS

UL/NFPA Approved Pressure Vacuum Vents protect your fuel from evaporation and in terms of highly flammable fuels it will keep the fuels away from the Tank perimeter.

Catalogue



UP DRAFT VENTS

Morrison Bros updraft vents are the pioneers in venting industry. the design



INTRINSICALLY SAFE ALARMS AND SENSORS



MORRISON BROS. CO.

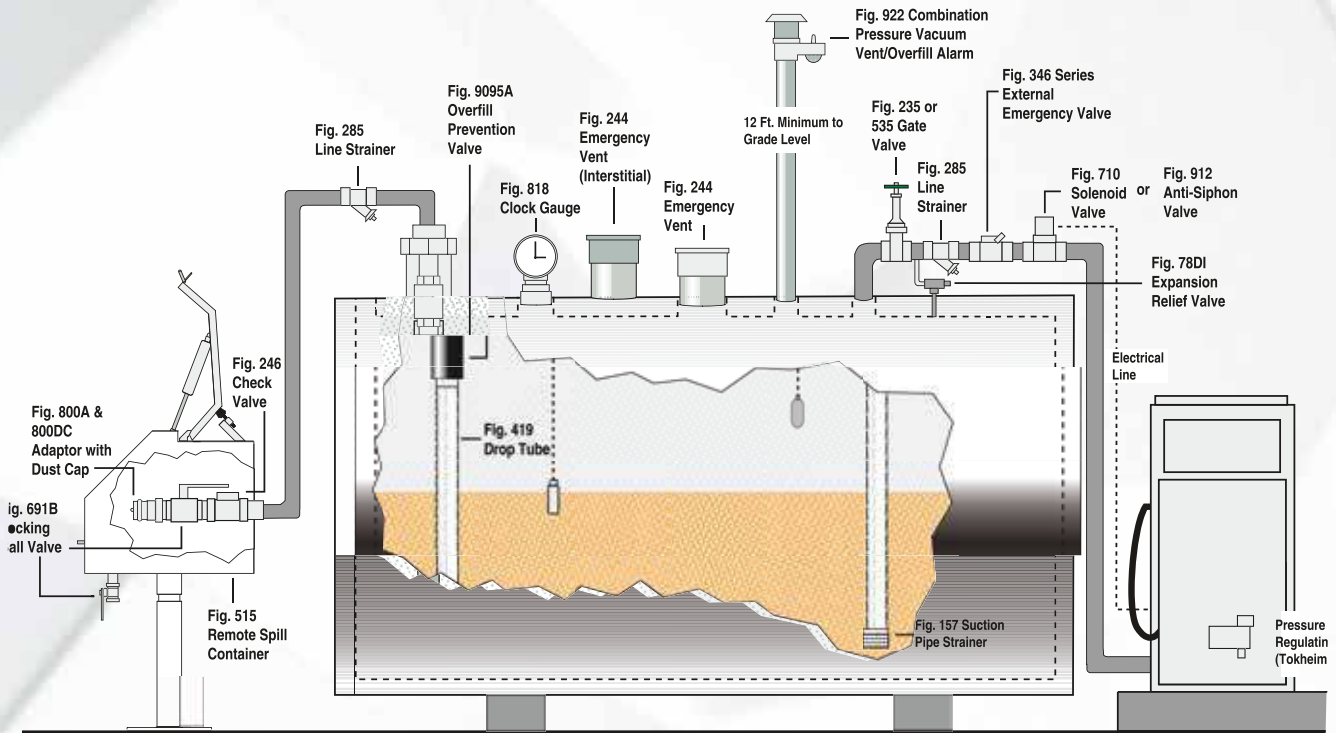

Remote Fill Box Series

Features:

- 7-gallon (26.5 liter) capacity (3" models) and 10-gallon (37.85 liter) capacity (2" models)
- 14 gauge steel (powder coated white)
- Pad-lockable
- Integral grounding stud
- Vapor recovery mounting brackets
- Sloped bottom (right to left)
- Drain located in front

OVERFILL PREVENTION VALVES



EMERGENCY VENTS





Containerized Solution For Fuels

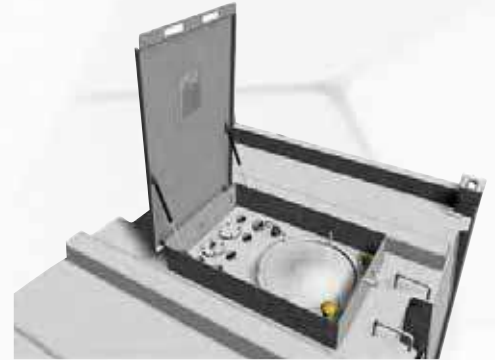
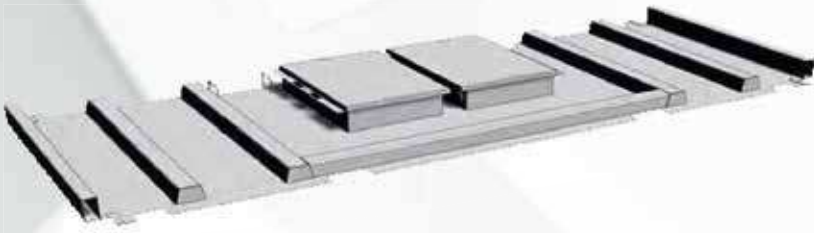

TANK INTERCONNECTION DIAGRAM

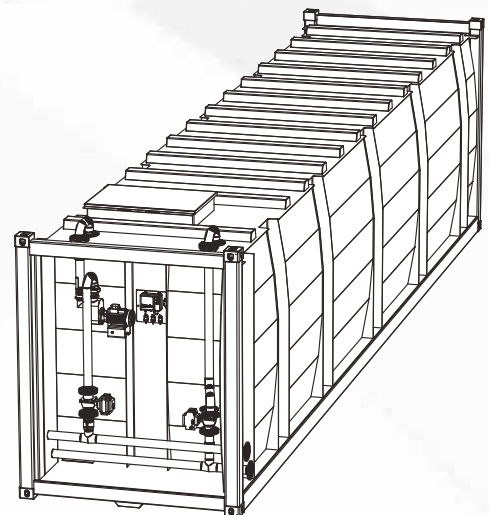
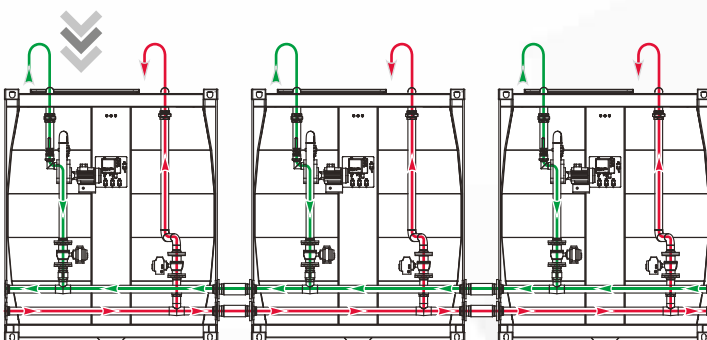



Engineering & Design

Applying our engineering skill set in the design of equipment, structures and Parts is our specialty. From manufacturing process selection, materials selection, DFMA, tolerance analysis, and more, our experience guides your project to success.

As 1138865 Max

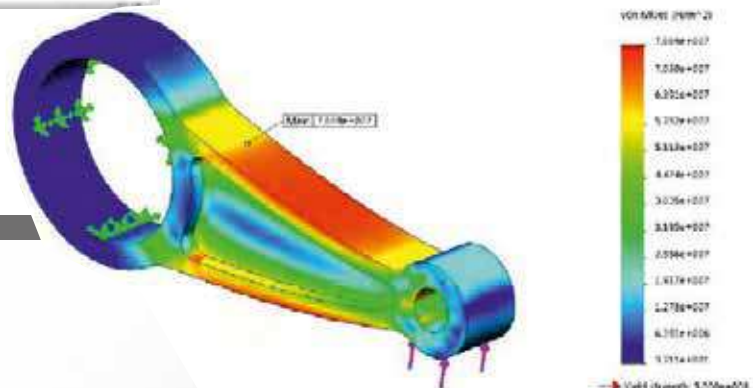
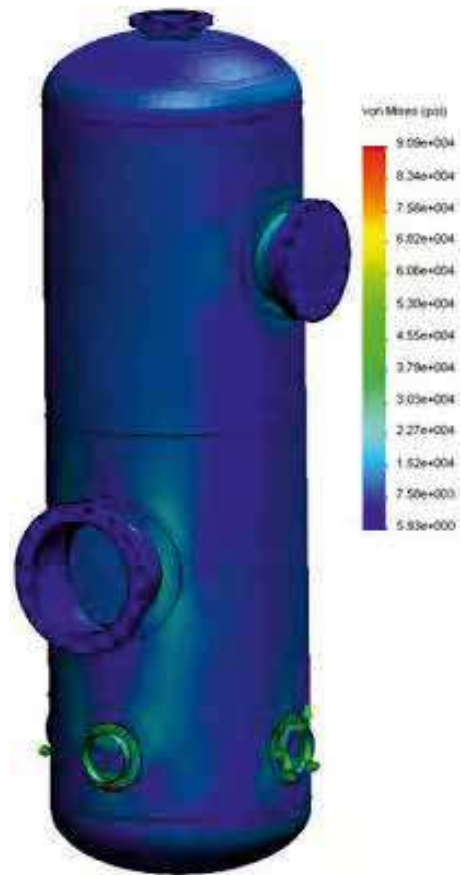
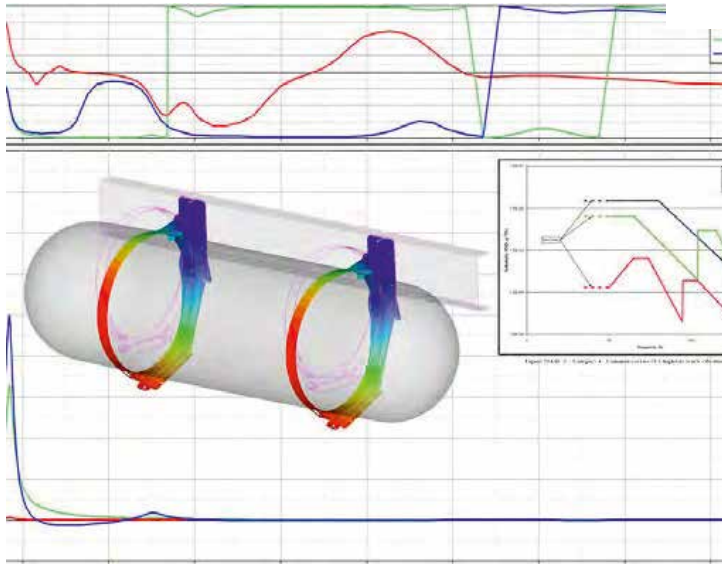
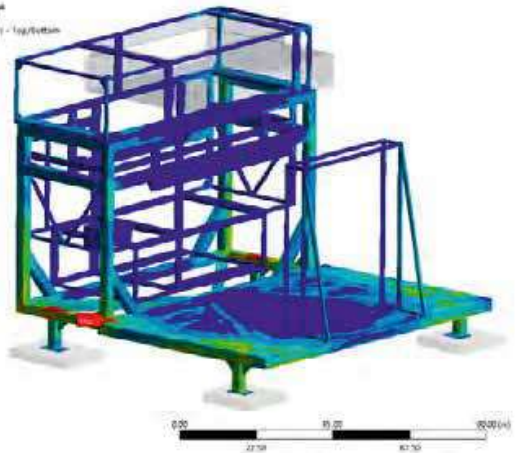
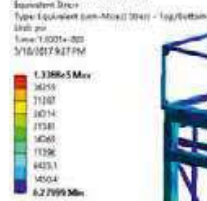

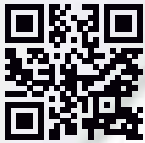

✉ sales@cochinsteeluae.com

🌐 www.cochinsteeluae.com

CALL US:

☎ +971 6 536 0401 (Line -1)
+971 6 531 0520 (Line -2)

📱 +971 52 972 1034
+971 55 115 8778
+971 55 790 9948



COCHIN STEEL LLC

Manufacturing Excellence **redefined!**

📍 Cochin Steel LLC PO Box : 66449, Al Sajaa Industrial Area
Opposite Big Masjid and Big Bazaar - Sharjah - United Arab Emirates